

**ELEVATION VIEW**

SCALE: 1/4" = 1'0"

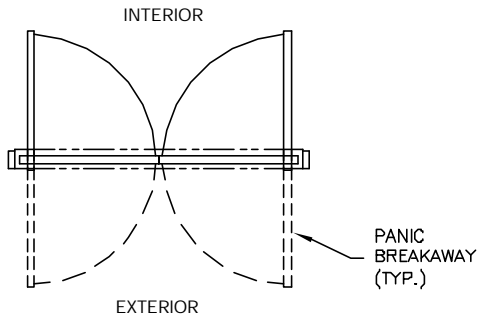

**PLAN VIEW**

SCALE: 1/4" = 1'0"

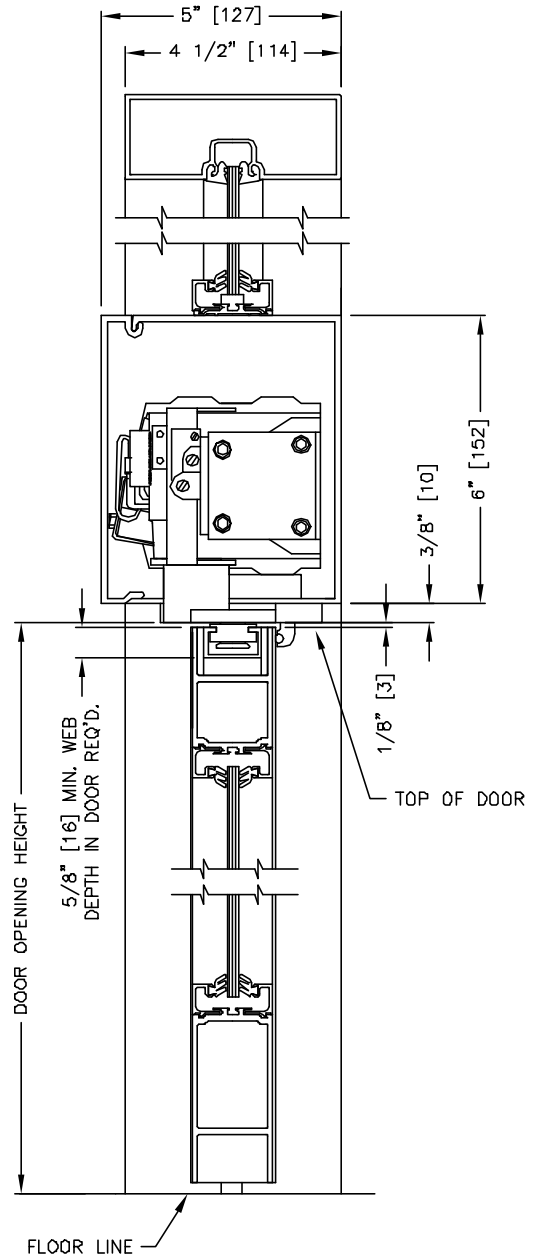

**SECTION: 2**

SCALE: 1/4 SIZE

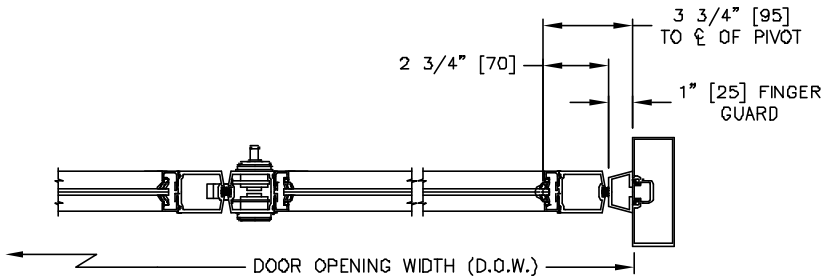

**SECTION: 1**

SCALE: 1/8 SIZE

**NOTE:** AUXILIARY DOOR STOP (BY OTHERS) REQUIRED AT FULL DOOR OPEN POSITION.

MEASUREMENTS GIVEN IN INCHES [MILLIMETERS].