

ELEVATION VIEW

SCALE: 1/4" = 1'0"

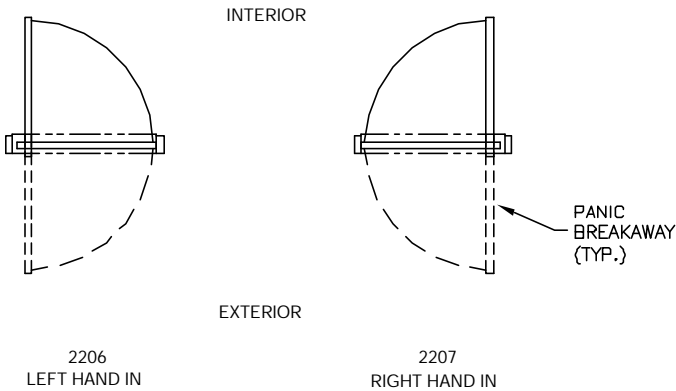

PLAN VIEW

SCALE: 1/4" = 1'0"

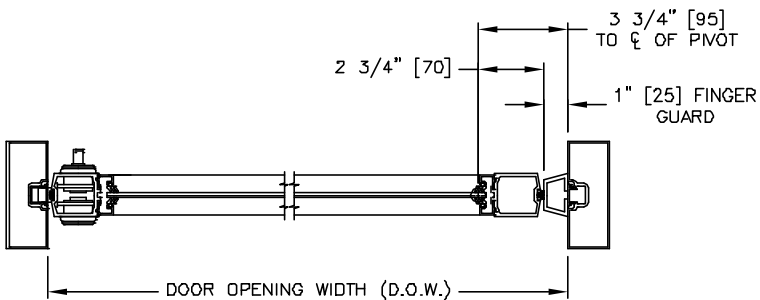

SECTION: 1

SCALE: 1/8 SIZE

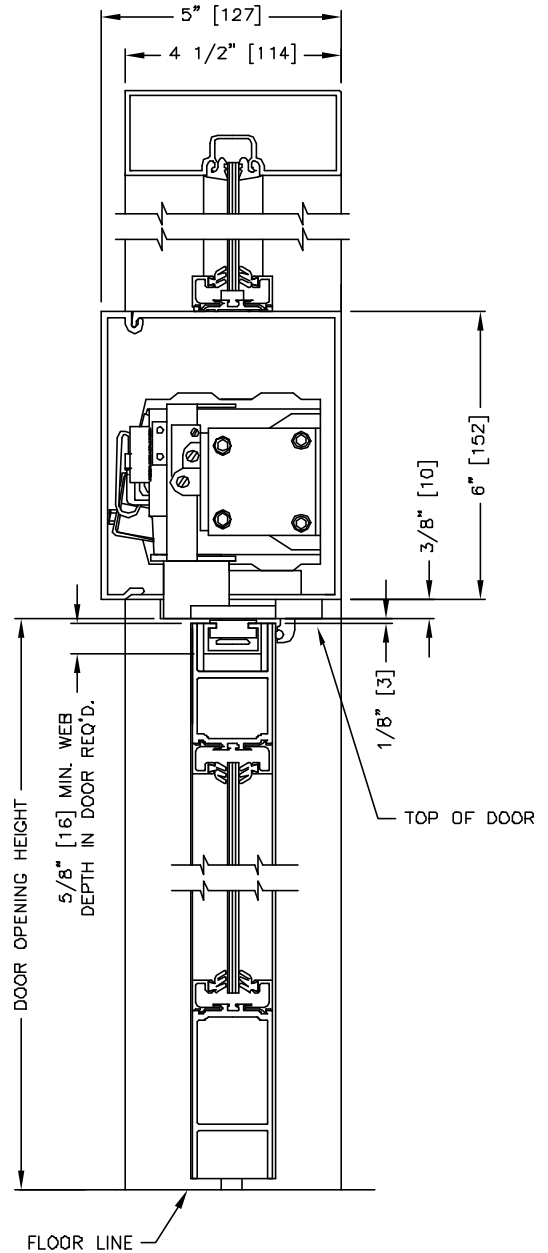

SECTION: 2

SCALE: 1/4 SIZE

RH IN (2207) SHOWN.
LH IN (2206) OPPOSITE.

MEASUREMENTS GIVEN IN INCHES [MILLIMETERS].